



LTE ANTENNA

Antenna GSM/UMTS/LTE
Screw Mount, 3 dBi, RG58/U 4.5 m, SMA(m)

AO-ALTE-MI3S

SECTRON company offers a wide portfolio of GSM/UMTS/LTE antennas with various versions differing in shape, level of gain and manner of attachment. SECTRON guarantees a compatible connection between an antenna and all antenna adaptors produced by SECTRON.

BENEFITS

- Low VSWR
- Omnidirectional radiation pattern
- Multiband antenna



FEATURES

AO-ALTE-MI3S

Technology	GSM/UMTS/LTE
Frequency bands	700~900/1700~2100/2500~2700 MHz
Bandwidth	-
Gain	3 dBi
VSWR	<2.0:1
Impedance	50 Ohm
Directivity	Omnidirectional
Beam angle	Attached graphs bellow
Polarization	Linear
Maximum input power	10 W
Power voltage	-
Dimensions	32.5 x 220 mm
Weight	218.44 g
Operating temperature	-30 to +80 °C
Execution	External
Method of attachment	Screw mount
Cable type	RG58/U
The cable length	4.5 m
Connector type	SMA(m)
Certification	RoHS, ISO9001, ISO14001

DRAWING

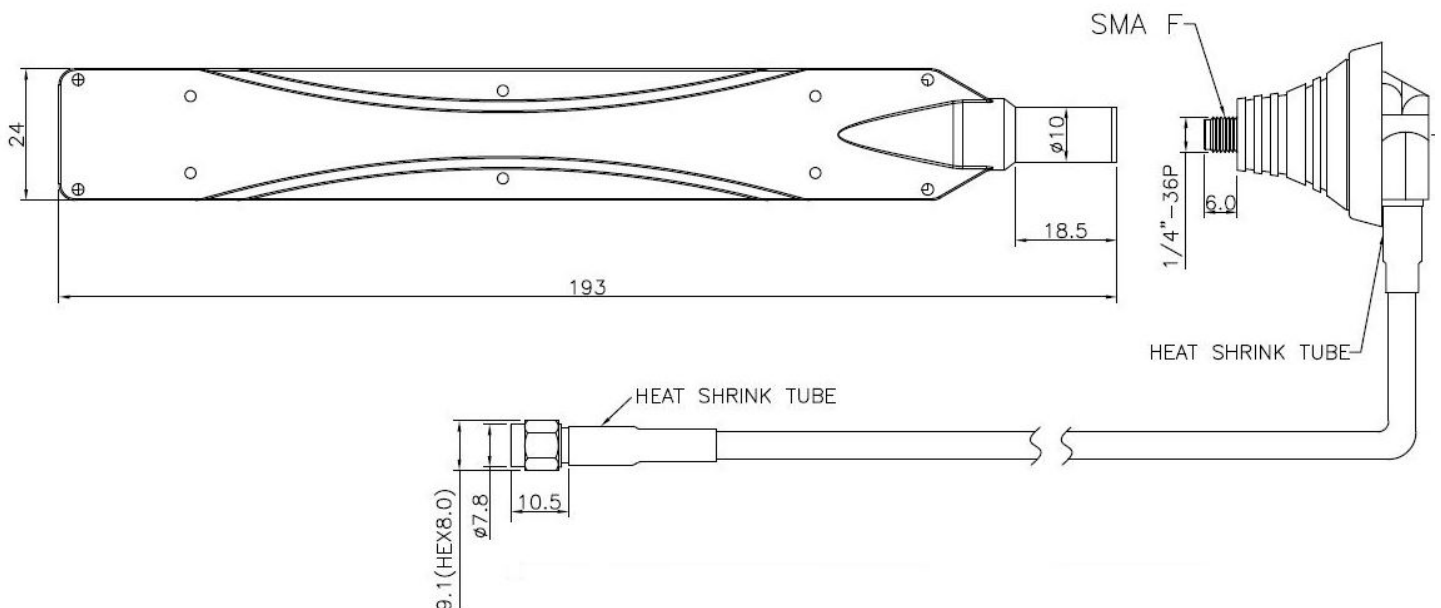

S_{11} - Return loss [dB]

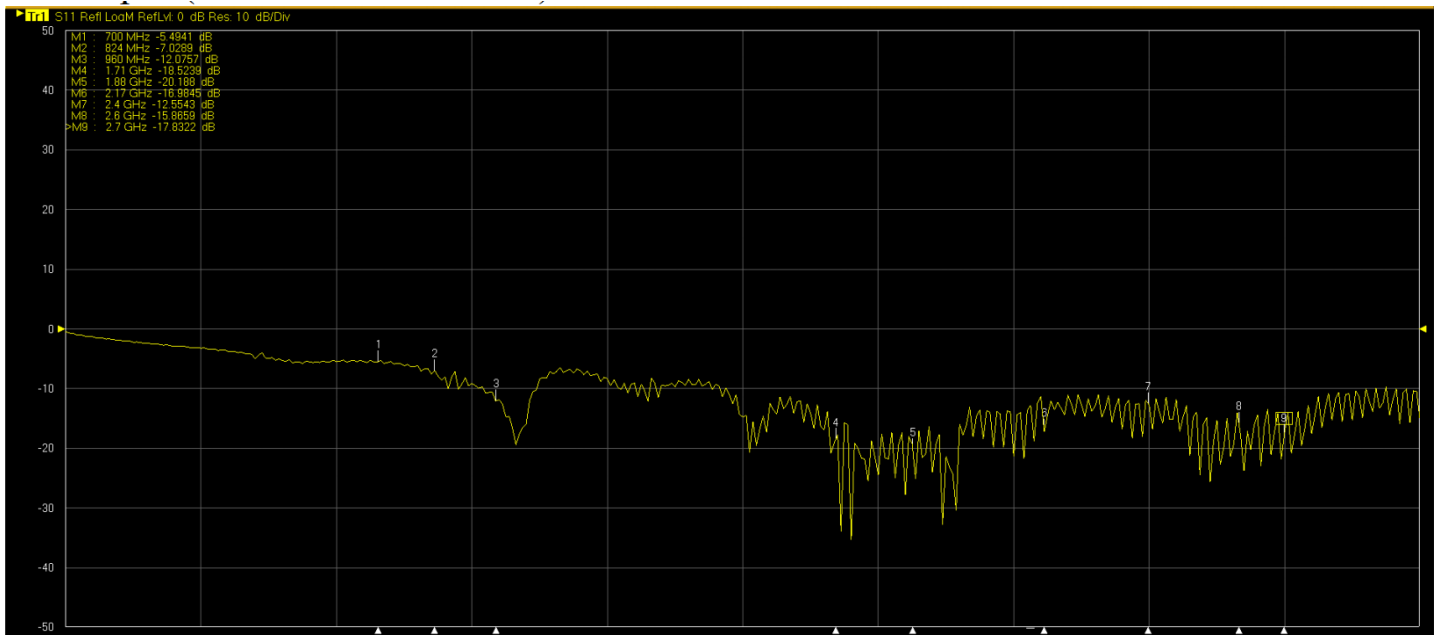

VSWR – Voltage standing wave ratio [-]

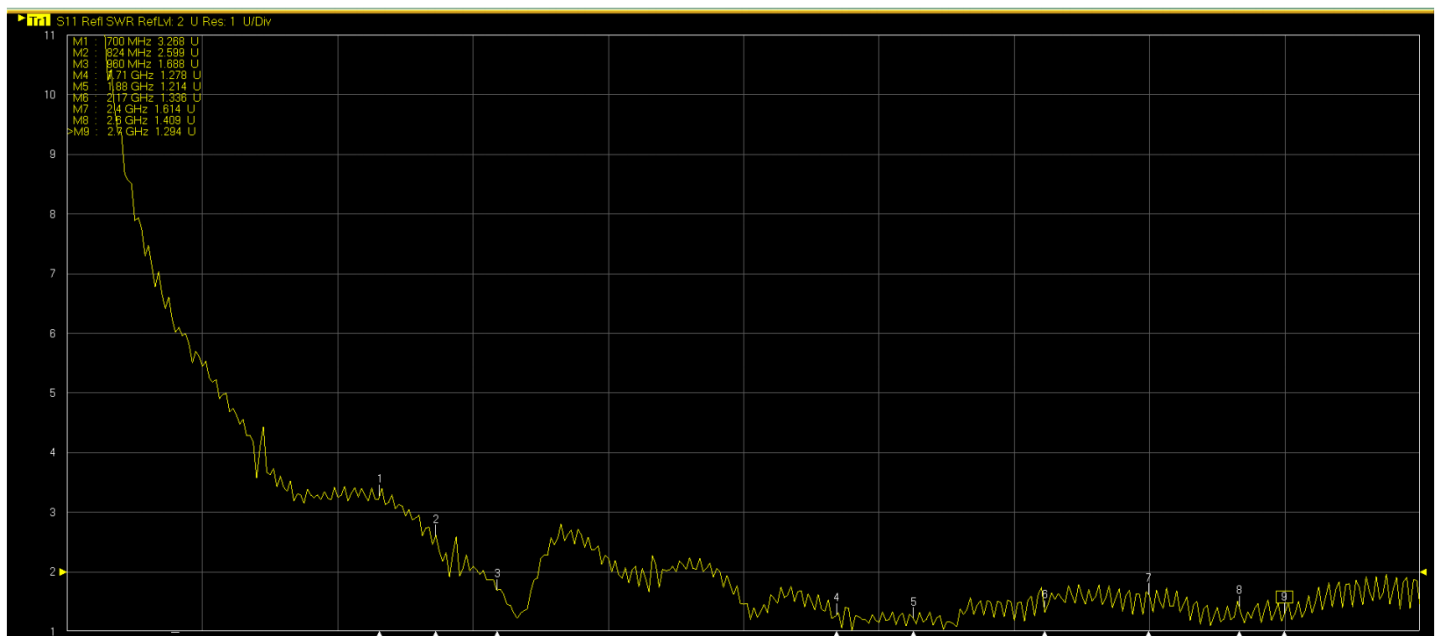

Radiation pattern

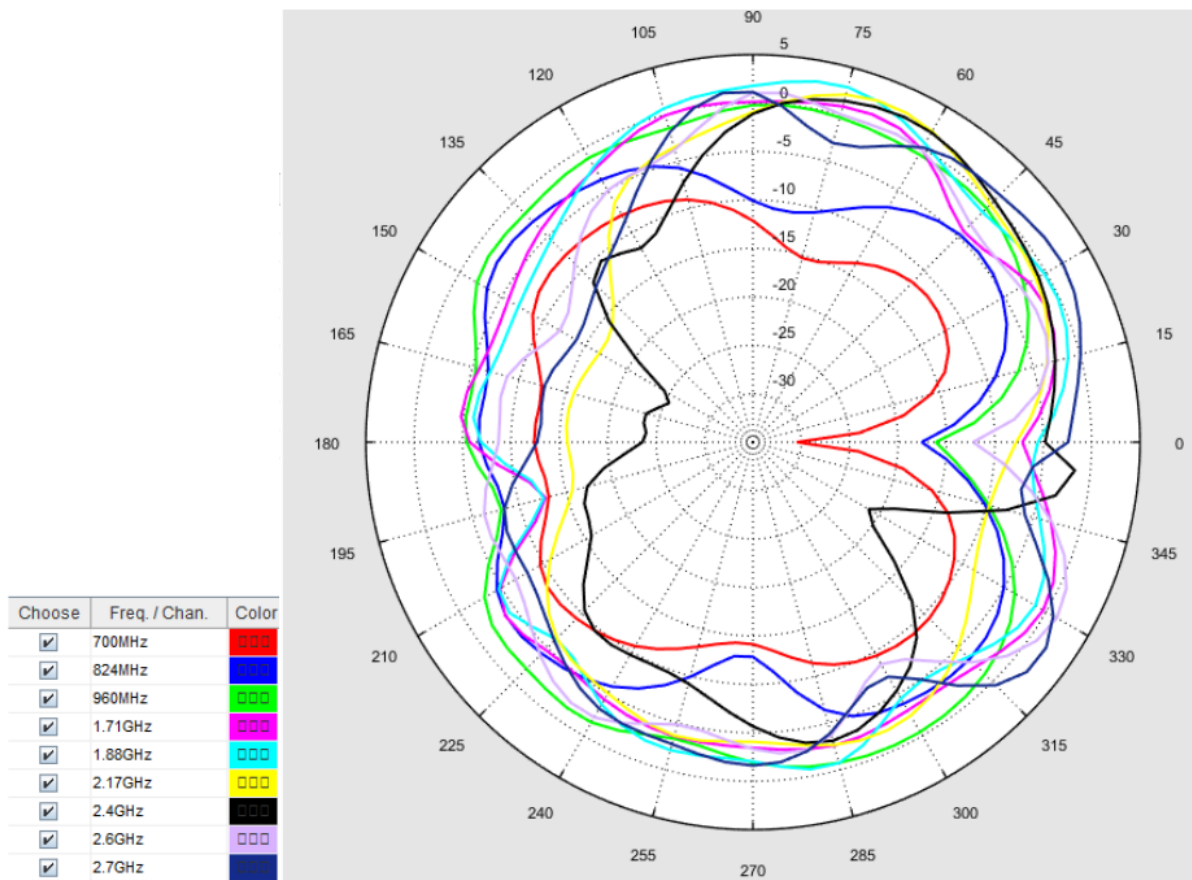

SUMMARY

Frequency [MHz]	S_{11} [dB]	VSWR [-]	Gain [dBi]
700	-5.49	3.26	-8.11
824	-7.02	2.59	-3.5
960	-12.07	1.68	0
1710	-18.52	1.27	0.2
1880	-20.18	1.21	3.3
2170	-16.98	1.33	2.5
2400	-12.55	1.61	2.4
2600	-15.86	1.40	1.8
2700	-17.83	1.29	2.2

VARIANTS

Different connector variants or cable lengths are available on request.

CONTACTS

SECTRON s.r.o. Josefa Šavla 1271/12
709 00 Ostrava 9, Czech Republic

WWW.SECTRON.CZ
Tel.: +420 556 621 020