



GSM/GPS ANTENNA

Antenna GSM/GPS Adhesive
FLAT, FME(f)/SMA(m),
2 x RG174/5m

AO-AGSM-GPSS

SECTRON company offers a wide portfolio of GSM/GPS antennas with various versions differing in shape, level of gain and manner of attachment. SECTRON guarantees a compatible connection between an antenna and all antenna adaptors produced by SECTRON.



BENEFITS

- Low VSWR
- Optimized high frequency gain
- Flexible

Technology	GSM/GPS
Frequency bands	800/900 MHz/1575.42 MHz
Bandwidth	-
Gain	3.5/30 dBi
VSWR	<1.8: 1/<2.0:1
Impedance	50 Ohm
Directivity	Omnidirectional
Beam angle	H 300° V 30°
Polarization	Linear/R.H.C.P.
Maximum input power	10 W
Power voltage	2.7 – 5.5V
Dimensions	123 x 61 x 18 mm
Weight	168.65 g
Operating temperature	-30 to +90 °C
Execution	External
Method of attachment	Adhesive
Cable type	RG174/U
The cable length	5 m
Connector type	FME(f)/SMA(m)

DRAWING

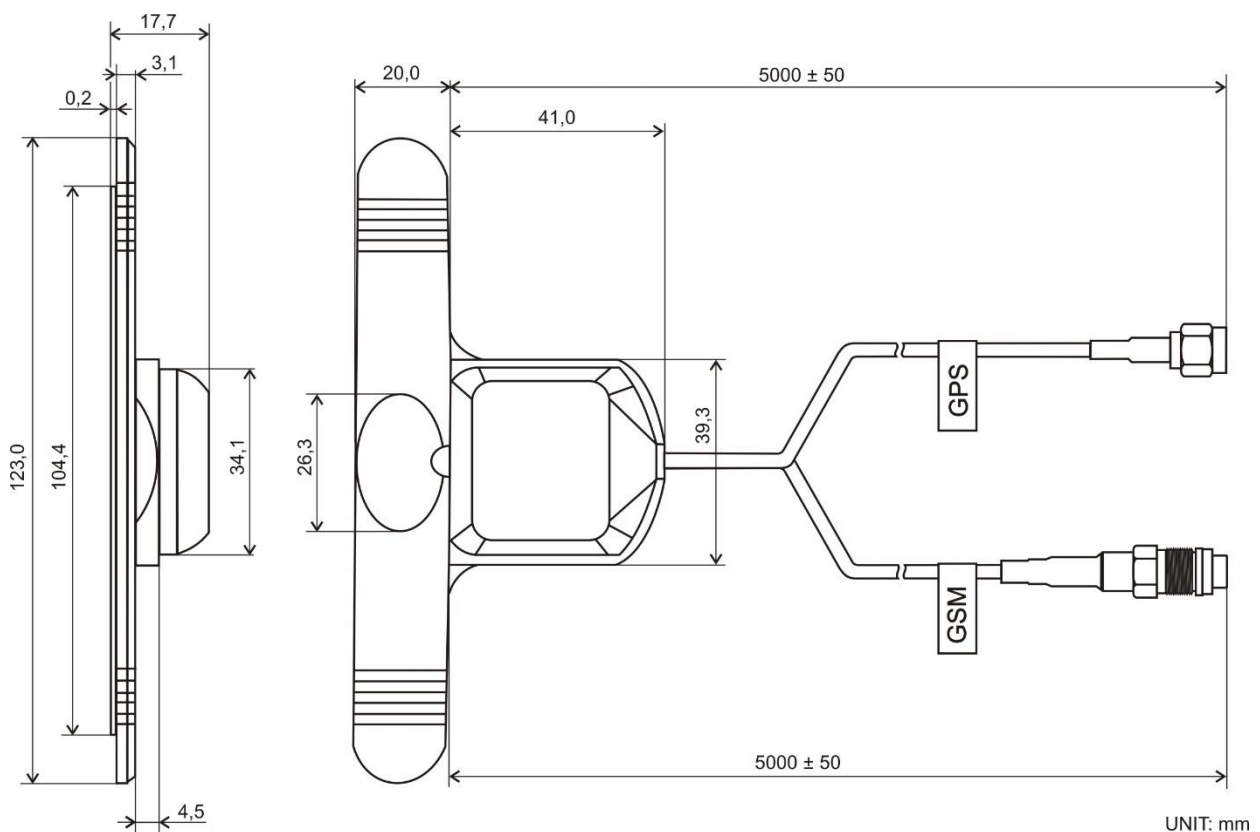

Different connector variants or cable lengths are available on request.

CONTACTS

SECTRON s.r.o. Josefa Šavla 1271/12
709 00 Ostrava 9, Czech Republic

WWW.SECTRON.CZ
Tel.: +420 556 621 021