

# QuSpot for RUT2xx

**Integrated multi-band 5G/LTE omni antenna + WiFi omni antenna + place to install Teltonika RUT281, RUT260, RUT241, RUT240, RUT230 or RUT200 (All-in-one)**

QuSpot omnidirectional 5G/LTE antenna for Teltonika **RUT281, RUT260, RUT241, RUT240, RUT230 or RUT200 routers** is a perfect outdoor device for mobile and fixed installations e.g. CCTV, hotspots, industrial areas, campervans, ships etc.. In addition to having omnidirectional, multi-band 5G/LTE antennas, **it has also embedded omnidirectional Wi-Fi antenna**. If you use RUT2xx with QuSpot antenna, you get an integrated complete solution with embedded router and multi band antennas in one enclosure.

**4G**  
LTE  
600-6350MHz  
4 dBi**Wi Fi** 2.4GHz  
DUALBAND 5GHz  
OMNI  
DIRECTIONAL  
IP 68  
-40° TO +80°

OUTDOOR ANTENNA WORKS IN **ANY**  
WEATHER CONDITIONS, IP68



ANTENNA **PERFECTLY MATCHED** WITH  
THE ROUTER



WALL OR MAST MOUNTING SYSTEM



MADE IN **EUROPE**

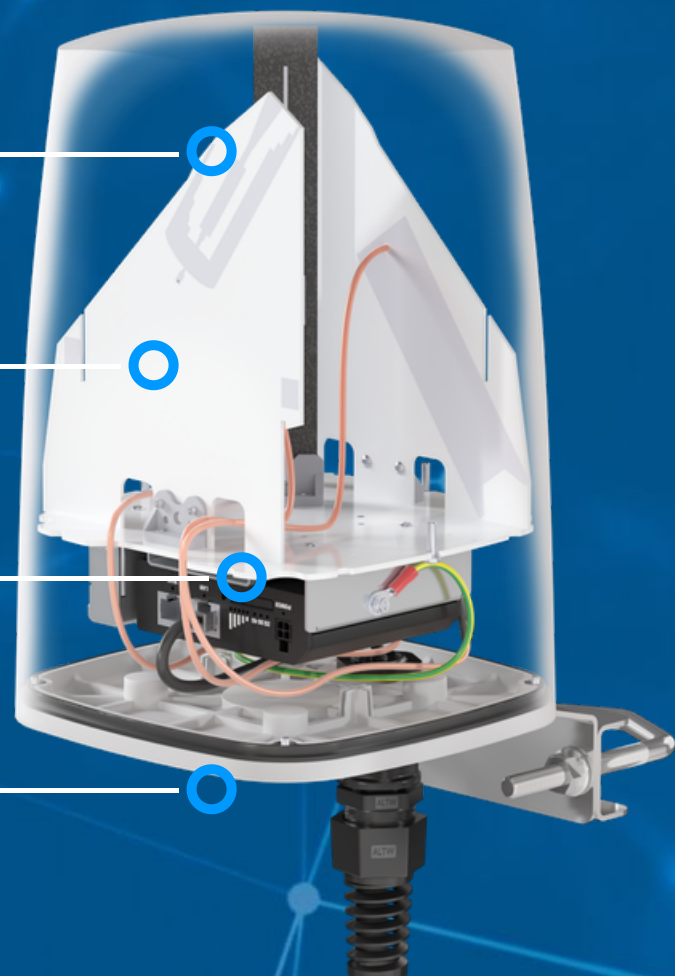

## 5G/LTE ANTENNA SPECIFICATION

<b>FREQUENCY</b>	0.6 - 1.4 GHz 1.5 - 3.0 GHz 3.0 - 5.0 GHz 5.0 - 6.35 GHz
<b>MAX. GAIN</b>	0.6 - 1.4 GHz : 2.6 dBi 1.5 - 3.0 GHz : 4.2 dBi 3.0 - 5.0 GHz : 4.4 dBi 5.0 - 6.35 GHz : 2.1 dBi
<b>SUPPORTED LTE BANDS</b>	1, 2, 3, 4, 5, 6, 7, 8, 9, 10, 12, 13, 14, 17, 18, 19, 20, 22, 23, 24, 25, 26, 27, 28, 29, 30, 33, 34, 35, 36, 37, 38, 39, 40, 41, 42, 43, 44, 46, 47, 48, 49, 52, 53, 54, 65, 66, 67, 68, 69, 70, 71, 85, 103, 106, 107, 111, 252, 253, 254, 255, 256
<b>SUPPORTED 5G BANDS</b>	n1, n2, n3, n5, n7, n8, n12, n13, n14, n18, n20, n24, n25, n26, n28, n29, n30, n34, n38, n39, n40, n41, n46, n47, n48, n53, n54, n65, n66, n67, n68, n70, n71, n77, n78, n79, n80, n81, n82, n83, n84, n85, n86, n89, n90, n95, n97, n98, n99, n100, n101, n105, n106, n250, n251, n252, n253, n254, n255, n256
<b>VSWR</b>	<2.00, max <3.00
<b>BEAMWIDTH</b>	360°/35° ±5°
<b>POLARIZATION</b>	Vertical
<b>IMPEDANCE</b>	50 Ω

## WI-FI ANTENNA SPECIFICATION

<b>FREQUENCY</b>	2.4 - 2.5 GHz 5.0 - 7.2 GHz
<b>MAX. GAIN</b>	2.4 - 2.5 GHz: 6dBi 5 GHz: 7.5dBi 7 GHz: 7.5dBi
<b>VSWR</b>	< 1.50, max < 2.00
<b>BEAMWIDTH</b>	360°/25°
<b>POLARIZATION</b>	Vertical
<b>IMPEDANCE</b>	50 Ω

## MECHANICAL SPECIFICATION

<b>MATERIALS</b>	ABS, aluminum, PTFE
<b>CONNECTOR TYPE</b>	RJ45
<b>INGRESS PROTECTION</b>	IP68
<b>DIMENSIONS</b>	160 x 160 x 240 mm 6.3 x 6.3 x 9.45 inch
<b>WEIGHT</b>	1.5 kg 3.31 lbs
<b>OPERATING TEMPERATURE</b>	From -40°C to 80°C From -40°F to 176°F
<b>ENCLOSURE RECOMMENDED TIGHTENING TORQUE</b>	0.5 - 0.7 Nm

**MAST DIAMETER**

25-66 mm  
0.98-2.60 inch

## **PLOTS**

### VSWR for Wi-Fi antenna

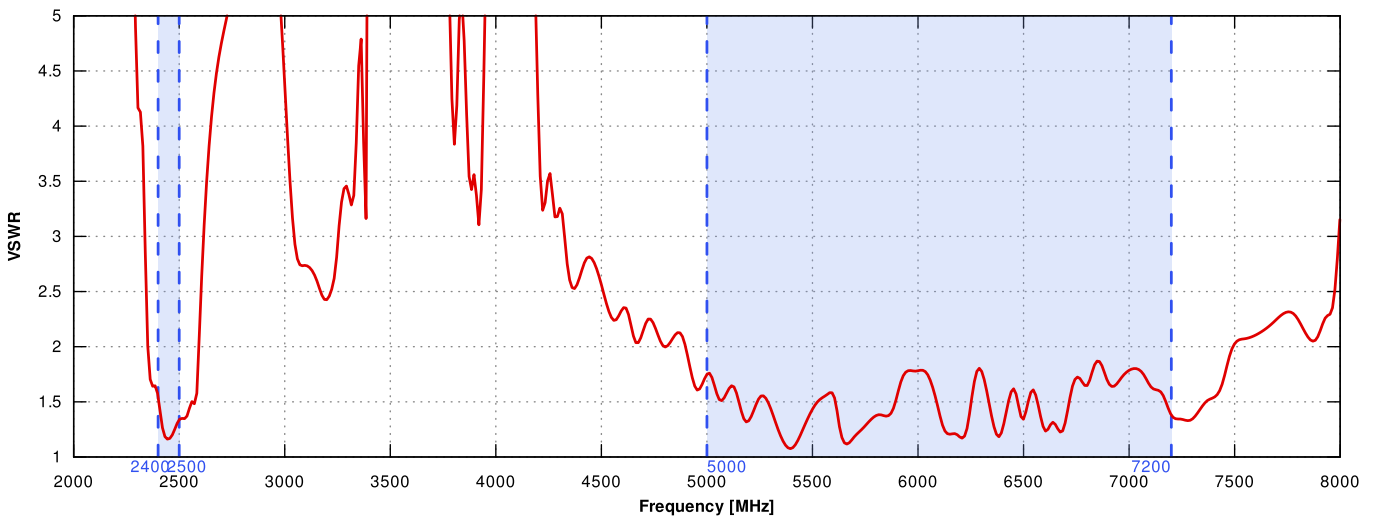

### VSWSR for 5G/LTE antenna

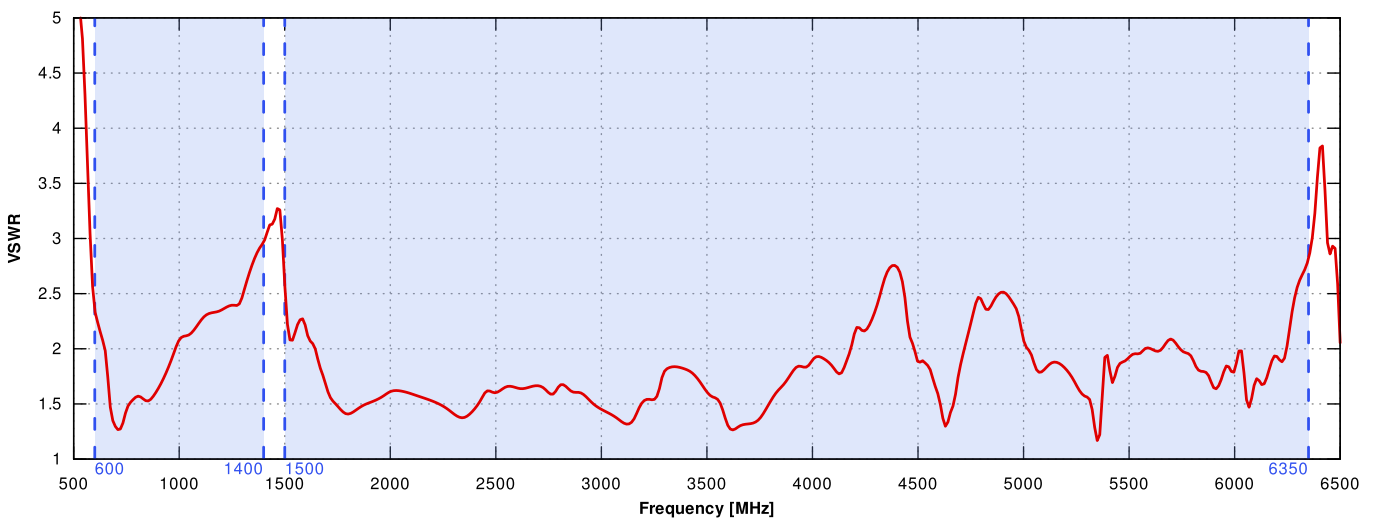

### Gain for Wi-Fi antenna

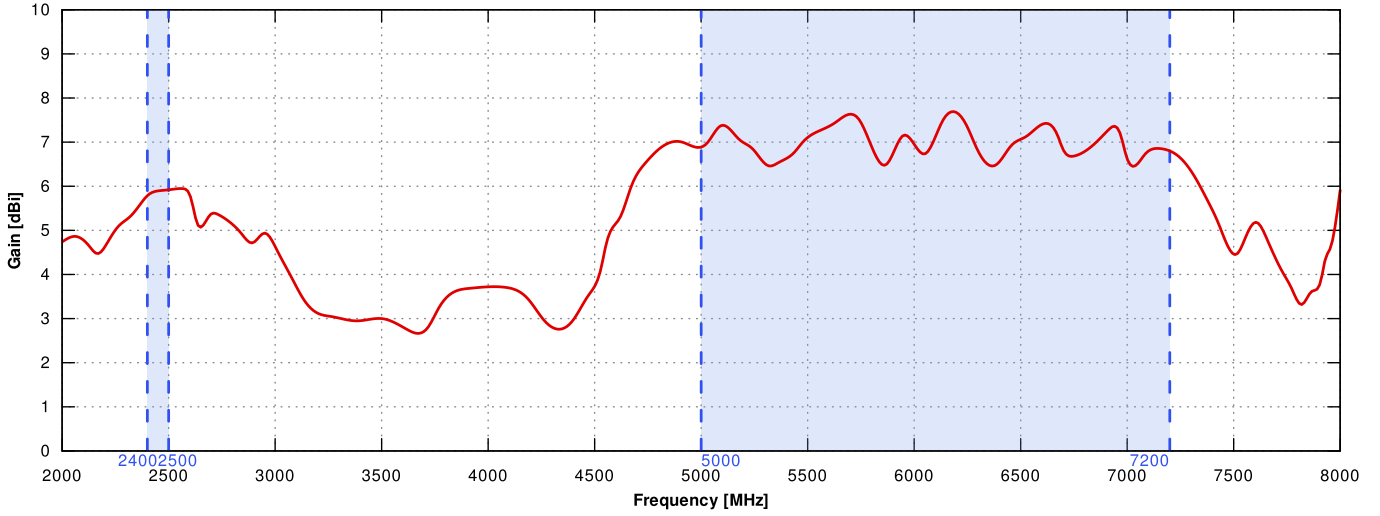

### Gain for 5G/LTE antenna

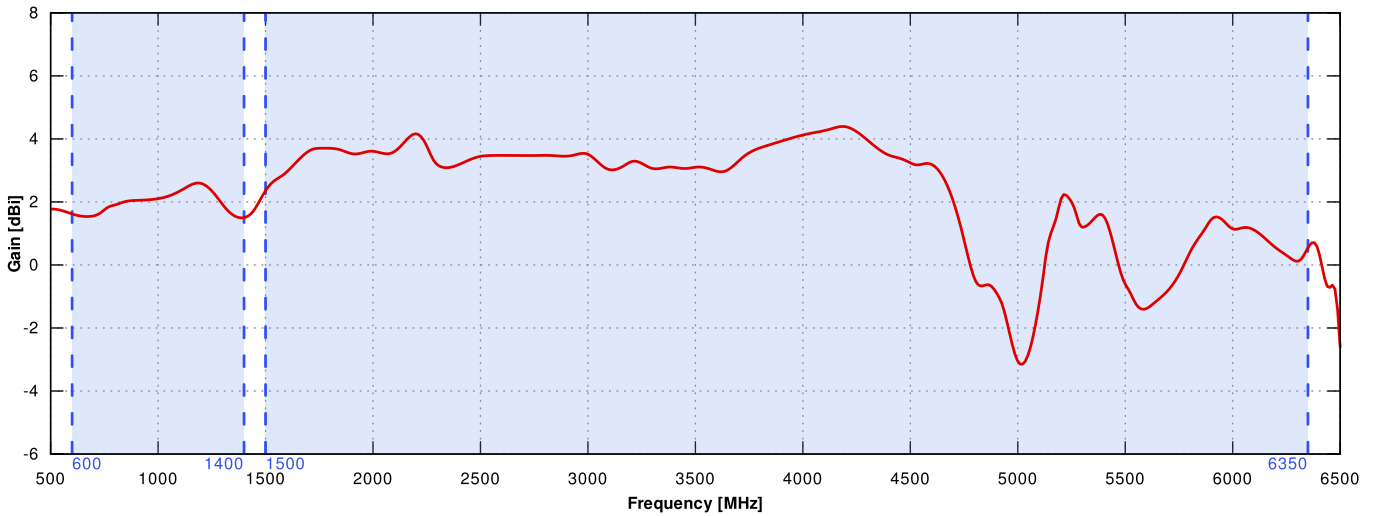

5G/LTE from 650MHz to 950MHz

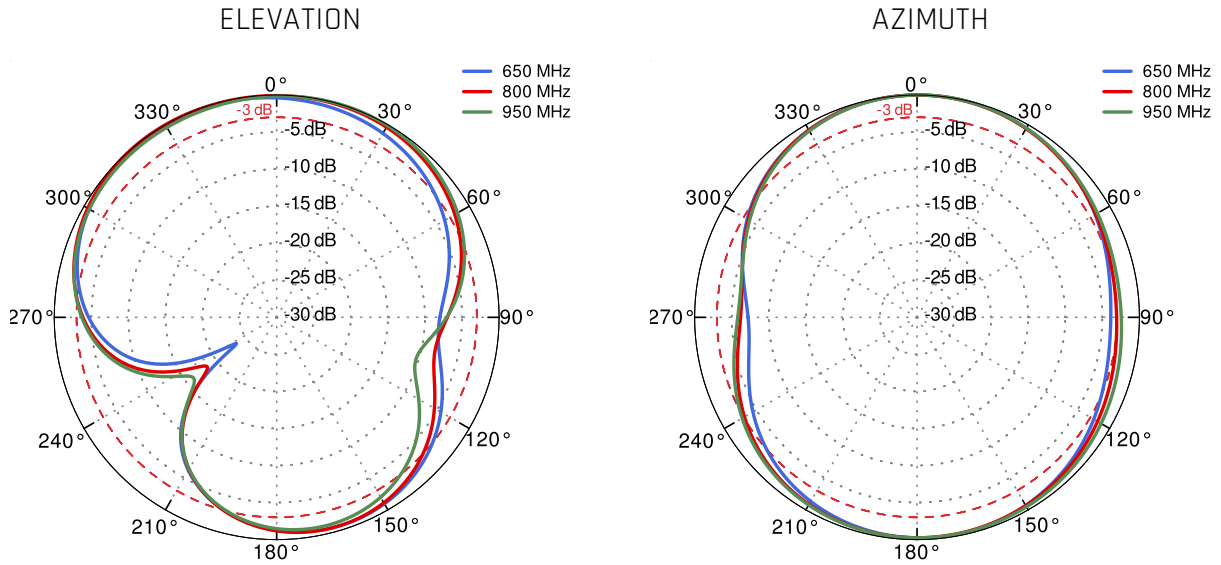

5G/LTE from 1.71GHz to 2.5GHz

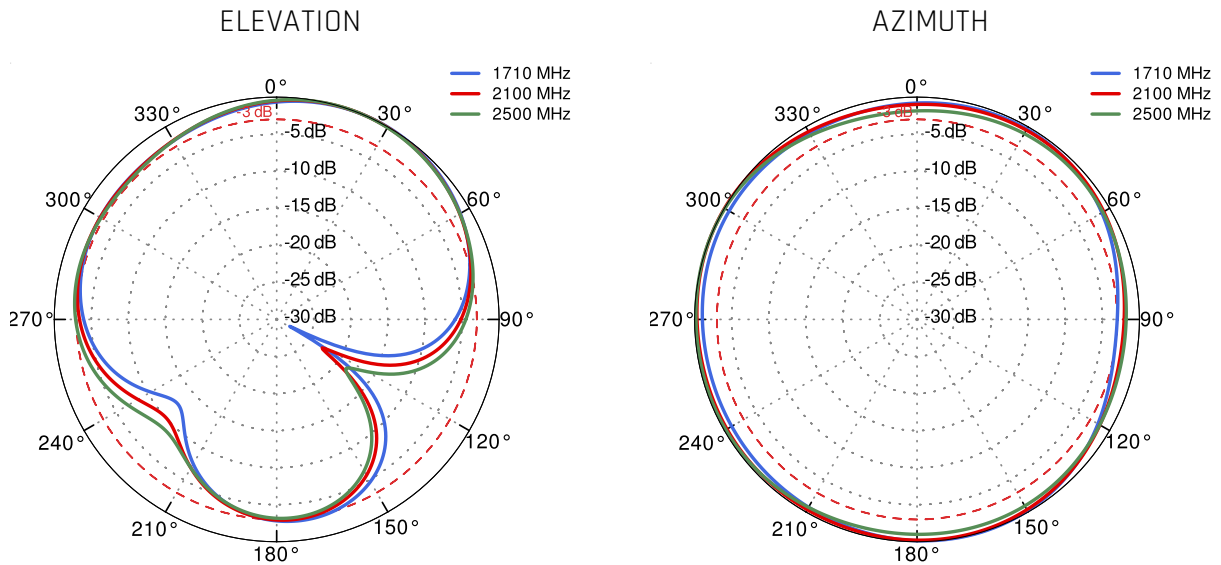

5G/LTE from 3.3GHz to 4.0GHz

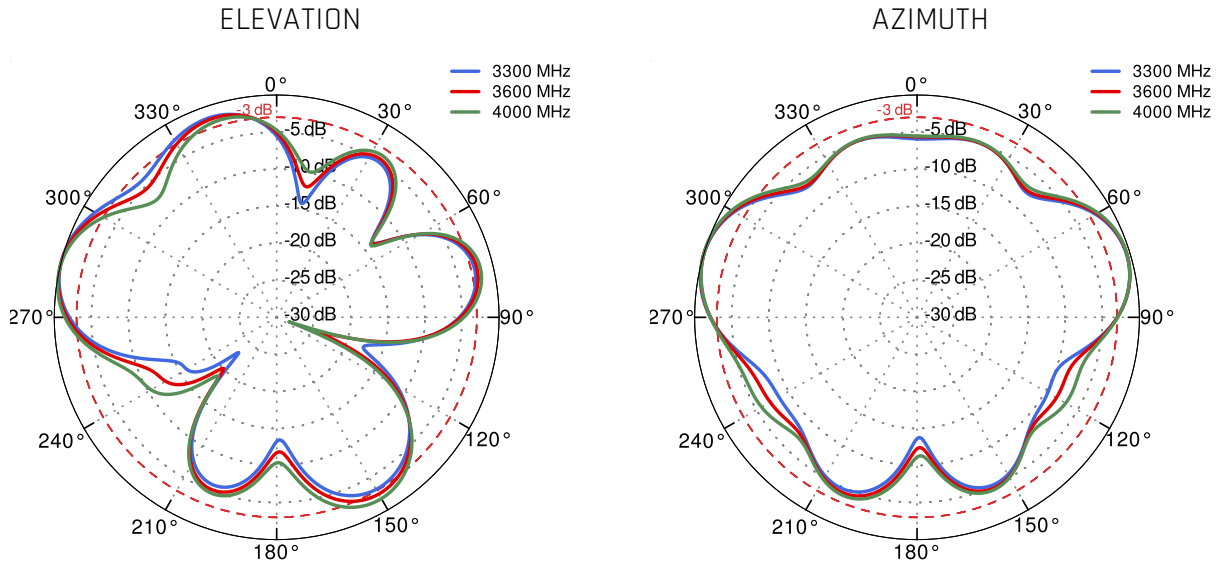

5G/LTE from 4.5GHz to 5.5GHz

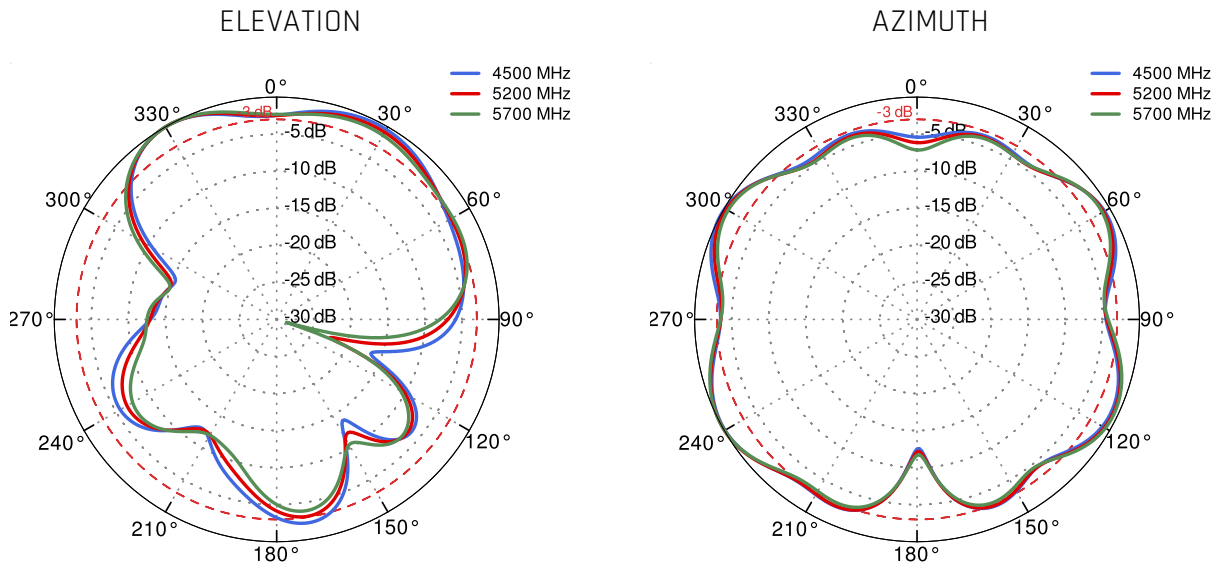

## Wi-Fi 2.4GHz and 5GHz

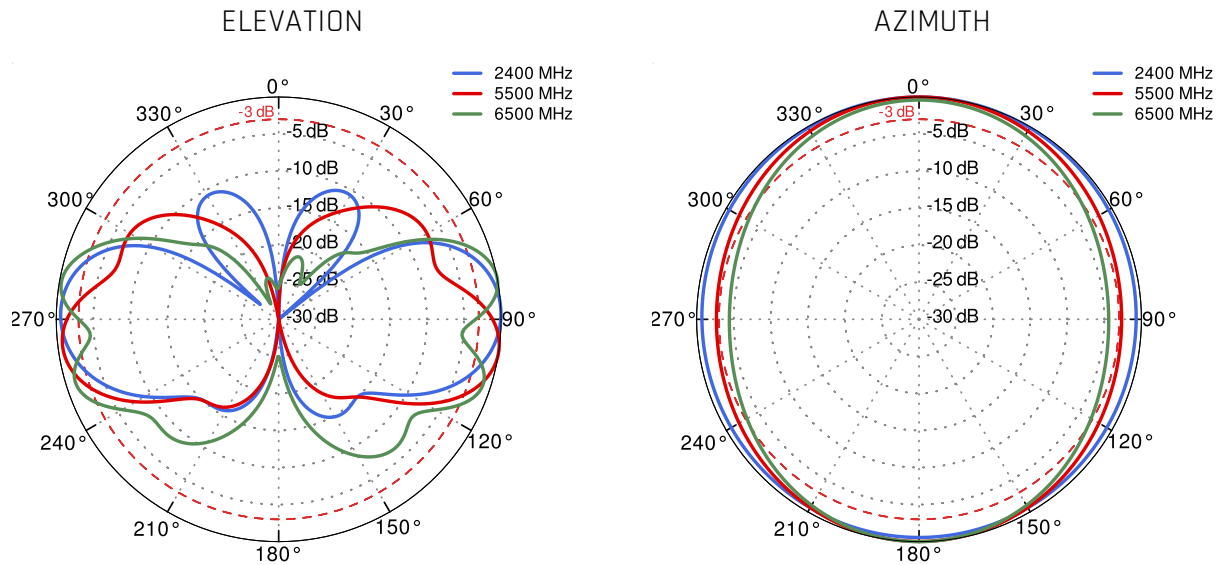

## DIMENSIONS

