



GSM/UMTS ANTENNA

Antenna GSM/UMTS

Magnetic 90, Quad-band,
9 dBi, SMA(m), RG58/3.5m

AO-AGSM-MG9S

SECTRON company offers a wide portfolio of GSM/UMTS antennas with various versions differing in shape, level of gain and manner of attachment. SECTRON guarantees a compatible connection between an antenna and all antenna adaptors produced by SECTRON.

BENEFITS

- Low VSWR
- High Gain
- Easy installation



Technology	GSM/UMTS
Frequency bands	900/1800/2100 MHz
Bandwidth	-
Gain	9 dBi
VSWR	<1.8:1
Impedance	50 Ohm
Directivity	Omnidirectional
Beam angle	H-360°,V-30°
Polarization	Vertical
Maximum input power	50 W
Power voltage	-
Dimensions	449.5 x Ø 70 mm
Weight	300 g
Operating temperature	-30 to +90 °C
Execution	External
Method of attachment	Magnetic
Cable type	RG58/U
The cable length	3.5 m
Connector type	SMA(m)

DRAWING

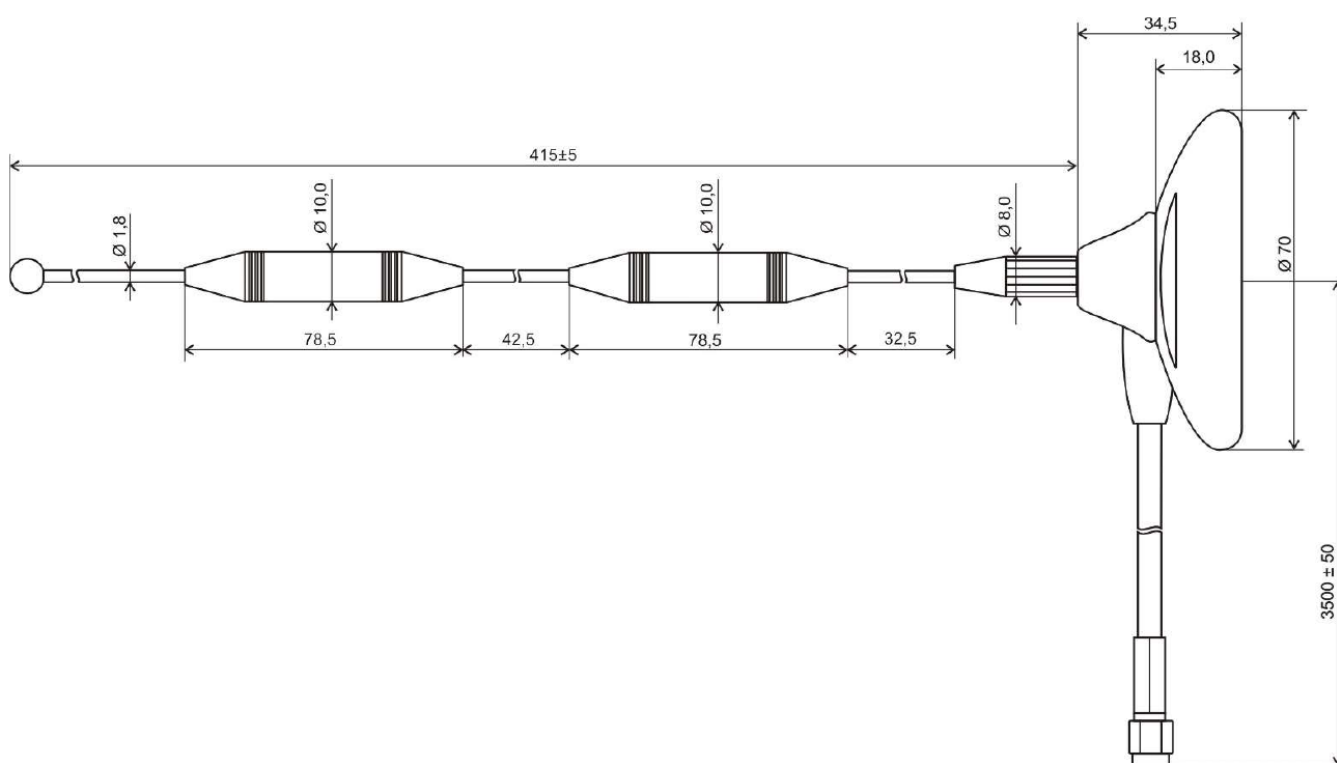

UNIT: mm

Radiation Pattern – simulated

H-plane

900 MHz

E-plane

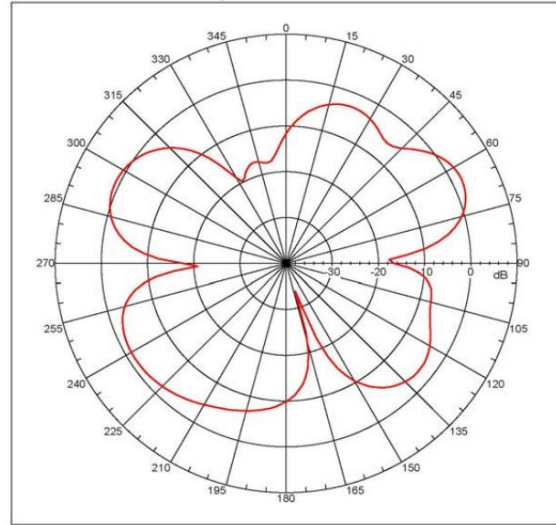
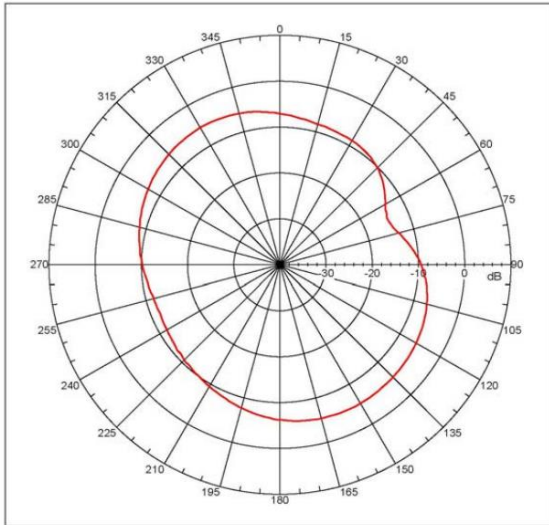

H-plane

1 800 MHz

E-plane

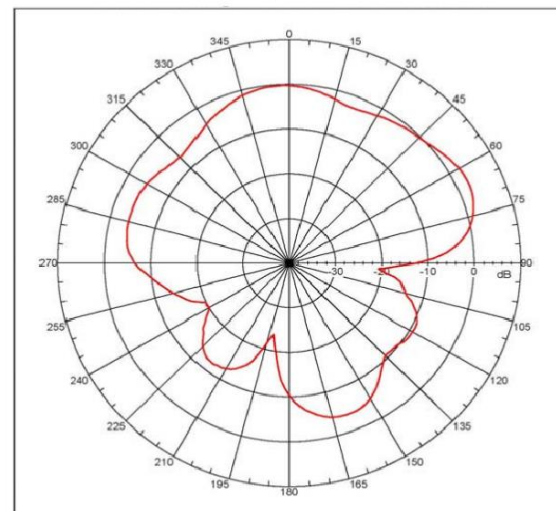
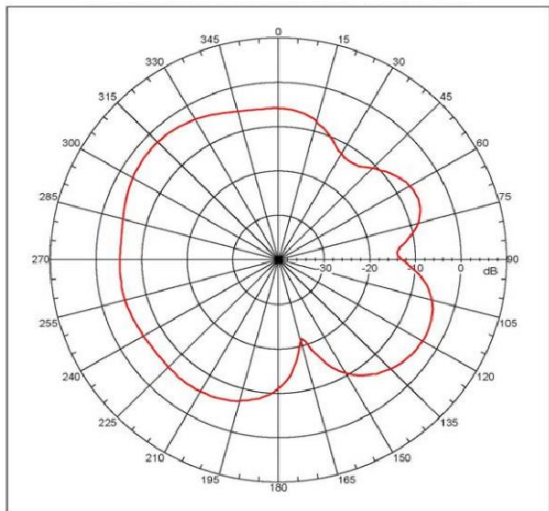

H-plane

2 100 MHz

E-plane

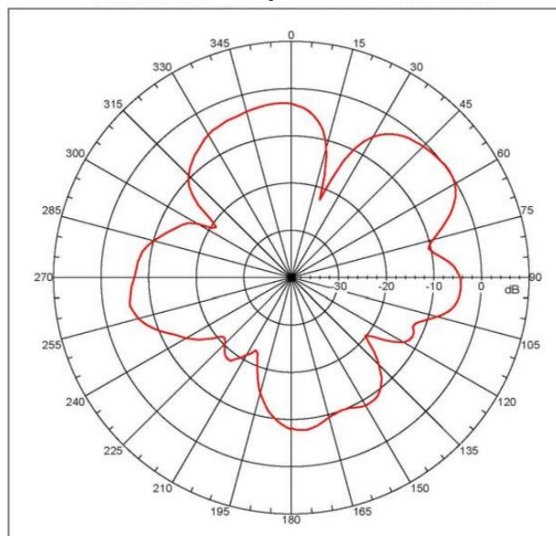
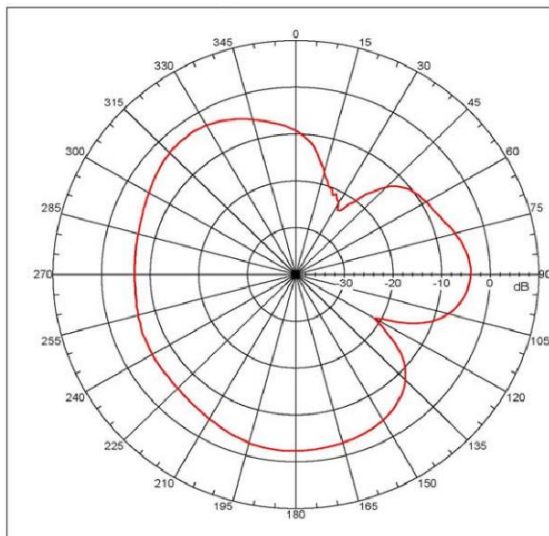

S11 - Return Loss [dB] – measured

Tr1 S11 Log Mag 10.00dB/REF 0.000dB [RO]

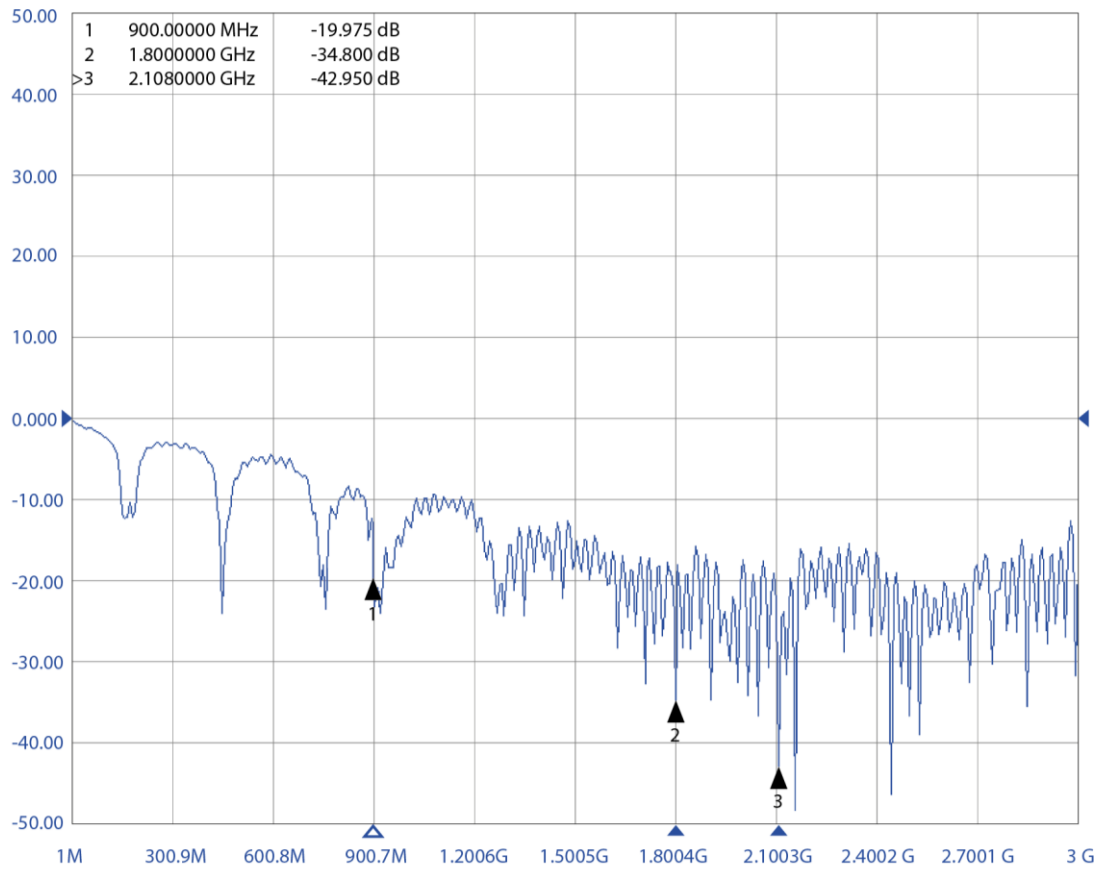

Frequency [MHz]	Return Loss [dB]	VSWR	Max. Gain [dBi]
900	-19.98	1.222: 1	8.1
1800	-34.8	1.037: 1	8
2100	-42.95	1.014: 1	9

Radiation pattern - measured

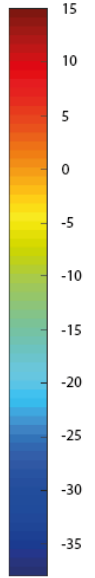
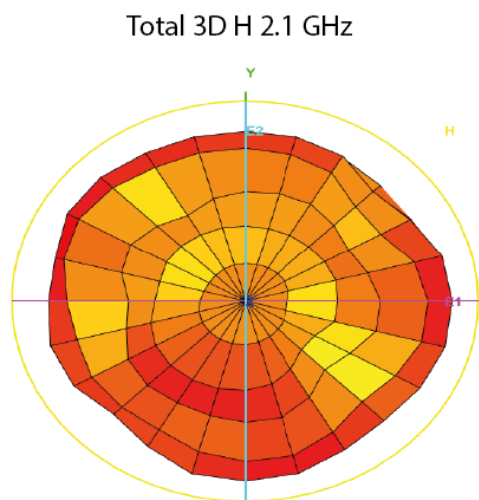
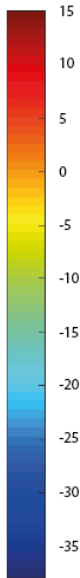
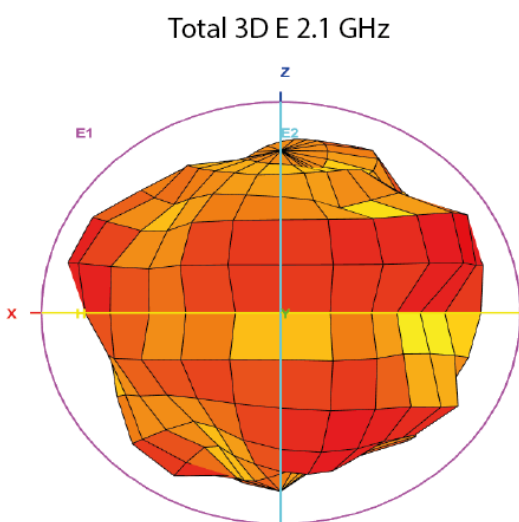
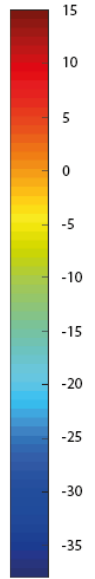
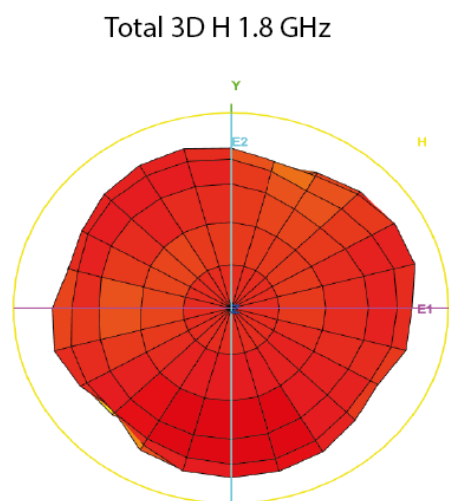
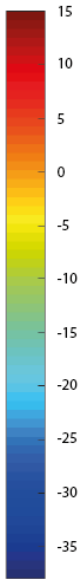
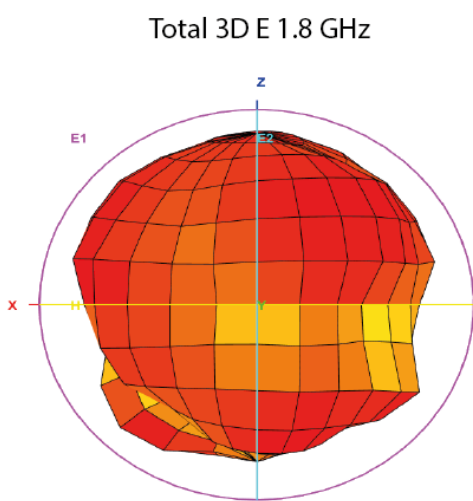
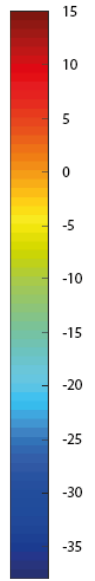
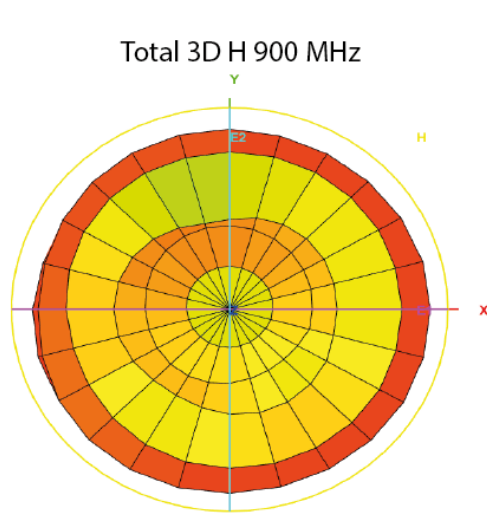
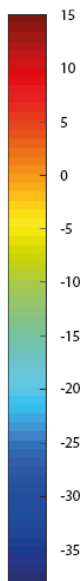
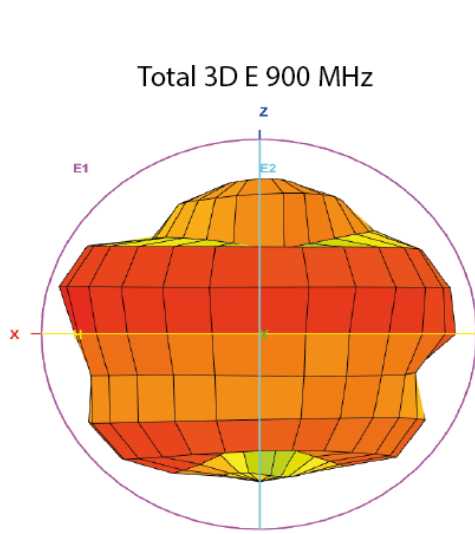

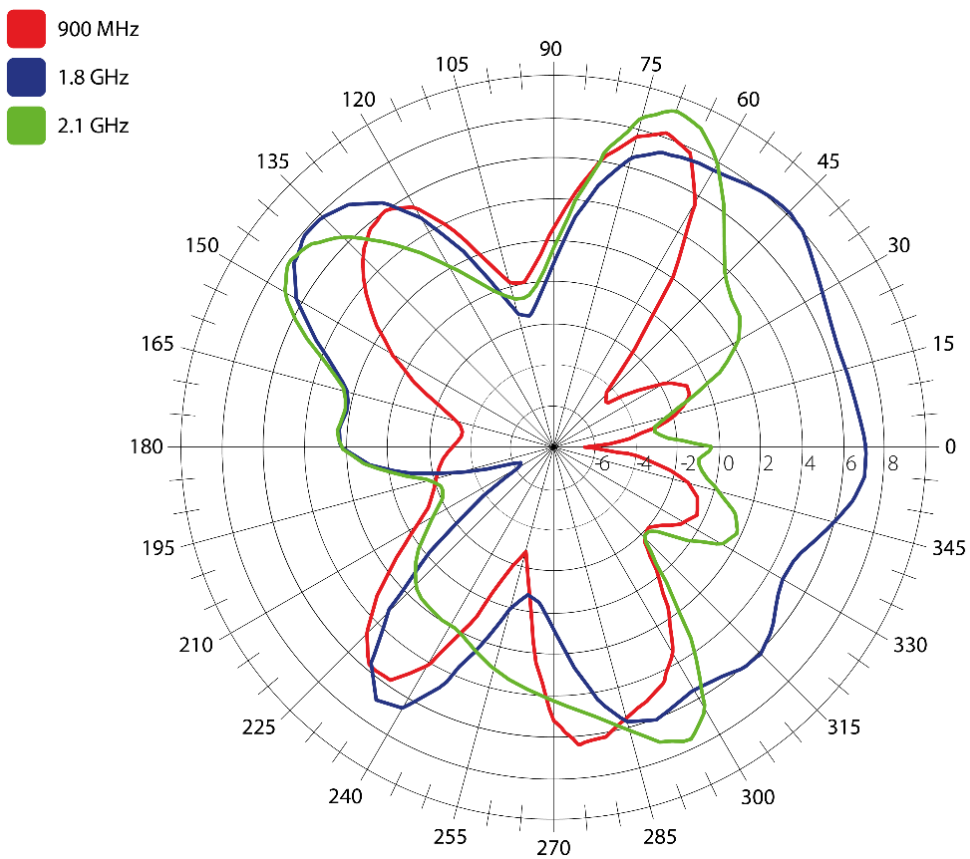

ALL VARIANTS

Different connector variants or cable lengths are available on request.

CONTACTS

SECTRON s.r.o. Josefa Šavla 1271/12
709 00 Ostrava 9, Czech Republic

WWW.SECTRON.CZ
Tel.: +420 556 621 021